

belgrade architects

50

beogradskih arhitekata



M. Čehovin: 1. Solarna kuća (1978); 2. Urbana kuća (1981);
 S. Žutić: 3. Njena kuća (1982); 4. Janusovo dvorište (1982);
 S. Maldini: 5. Hram vertikalne simetrije (1980); 8. Kuća od
 zemlje (1981); M. Musić: 6. Ulica sećanja (1980); 7. Slavija
 kroz moj prozor (1980); D. Ećimović: 9. Kuća br. 1 (1976); 10.
 Urbana kuća (1981); M.E.Č. – 11. Forum, Knez Mihajlova,
 (1982)

M. Čehovin: 1. Solar House (1978); 2. Urban House (1981);
 S. Žutić: 3. Her House (1982); 4. Janus Backyard (1982); S.
 Maldini: 5. Temple of Vertical Symmetry (1980); 8. Clay
 House (1981); M. Musić: 6. Rememberance Street (1980);
 7. Slavija from my Window (1980); D. Ećimović: 9. House
 no. 1 (1976); 10. Urban House (1981); M.E.Č. – 11. Forum,
 Knez Mihajlova Street (1982)

grupa
M.E.Č.

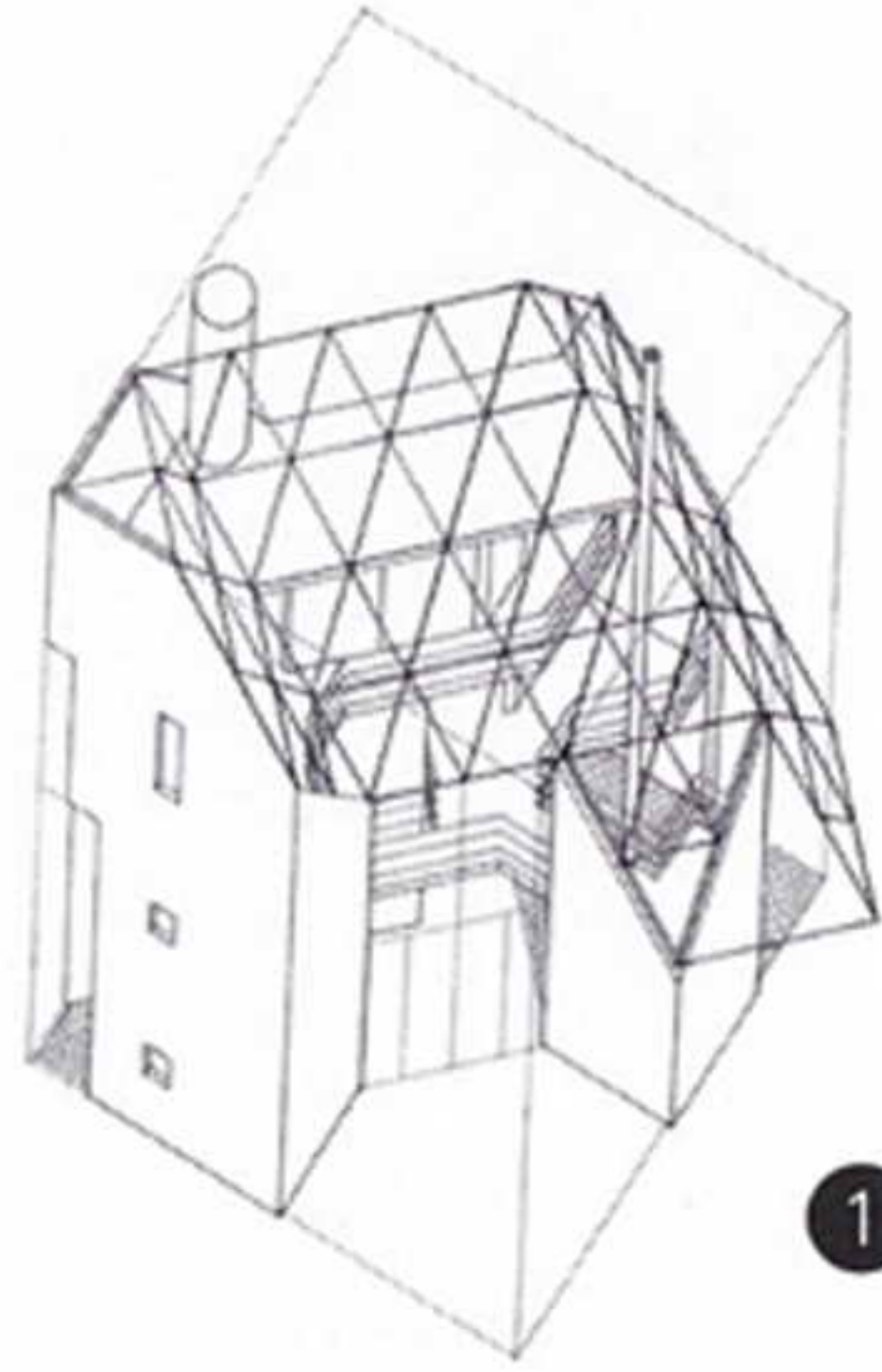

1

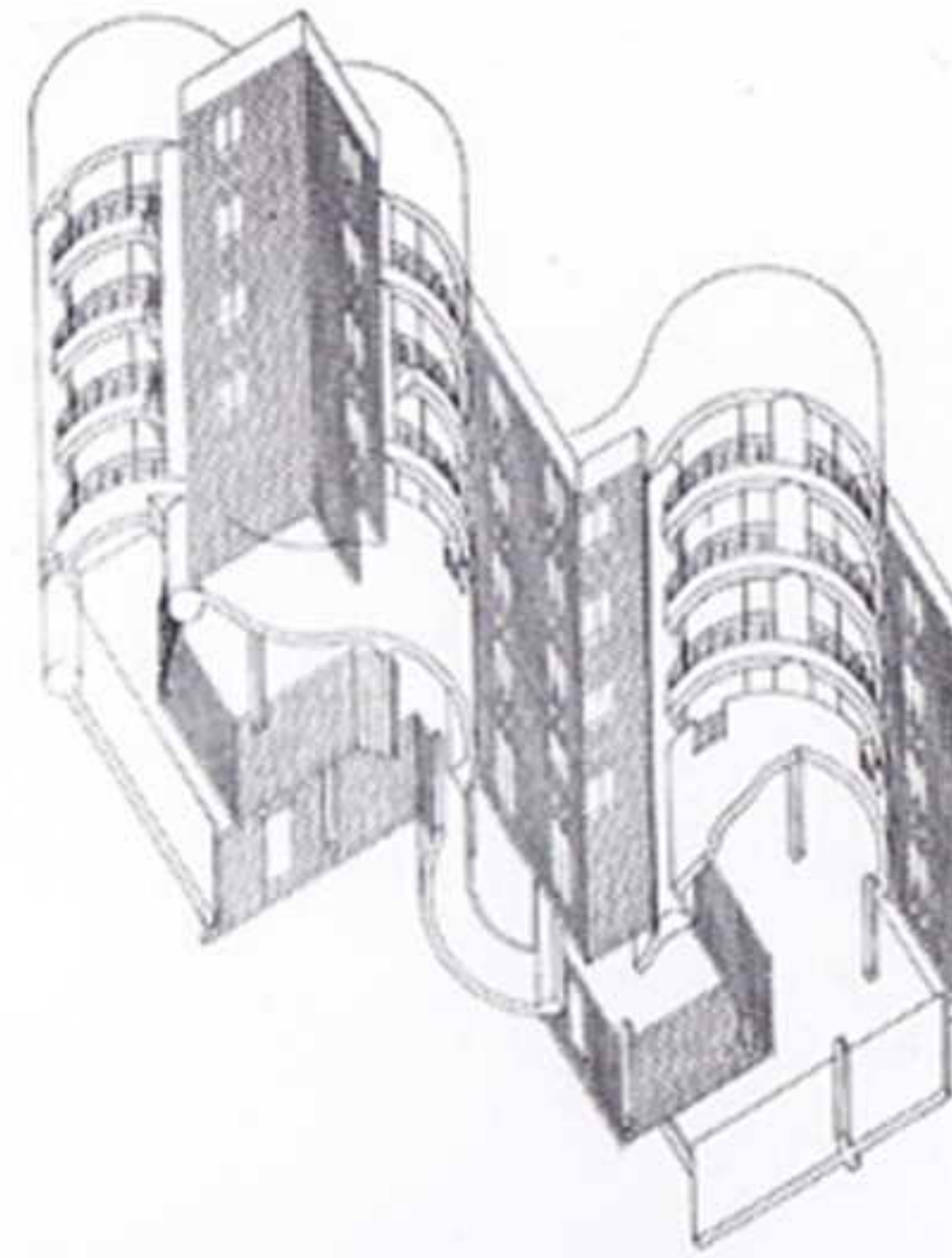

2

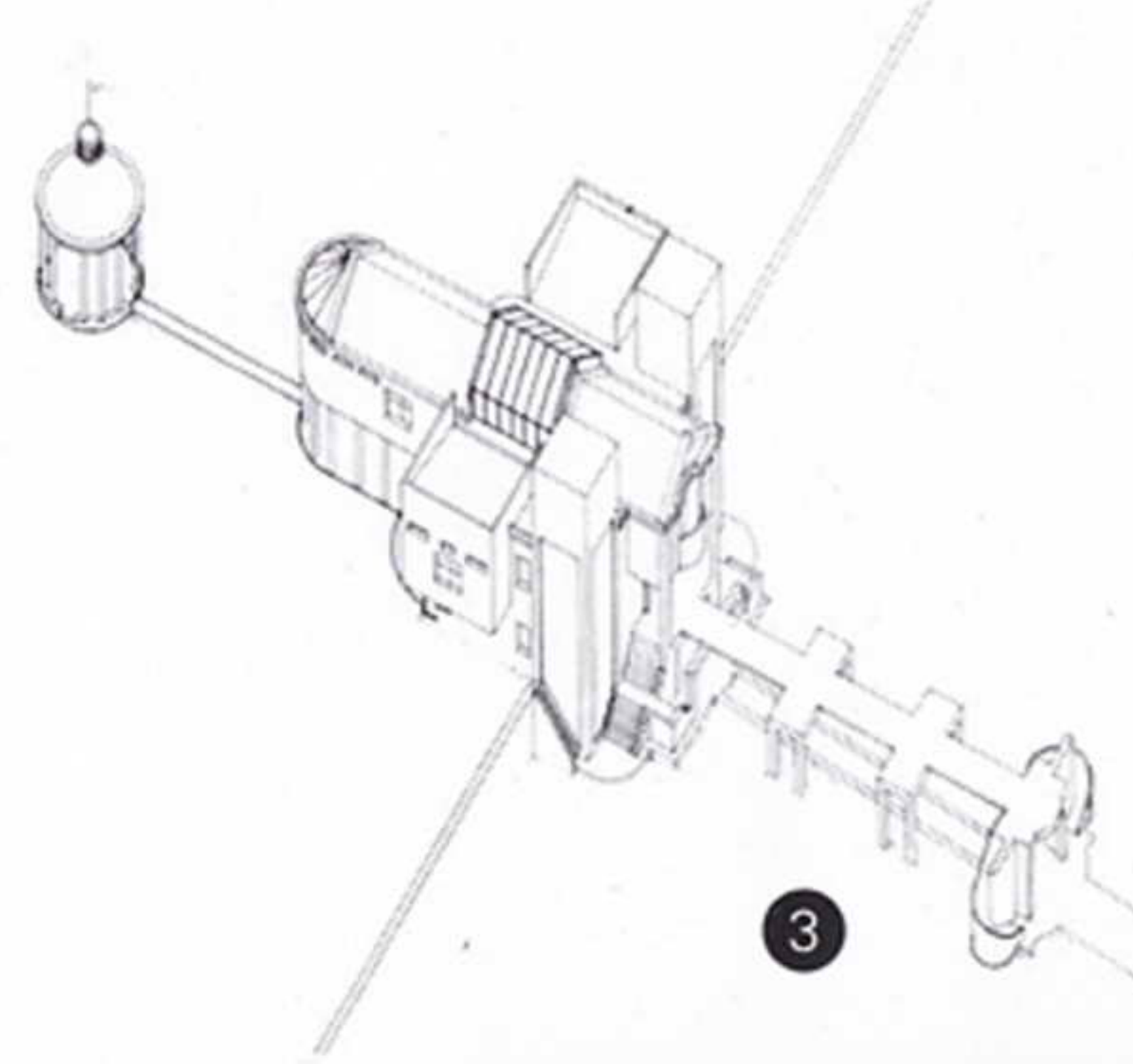

3

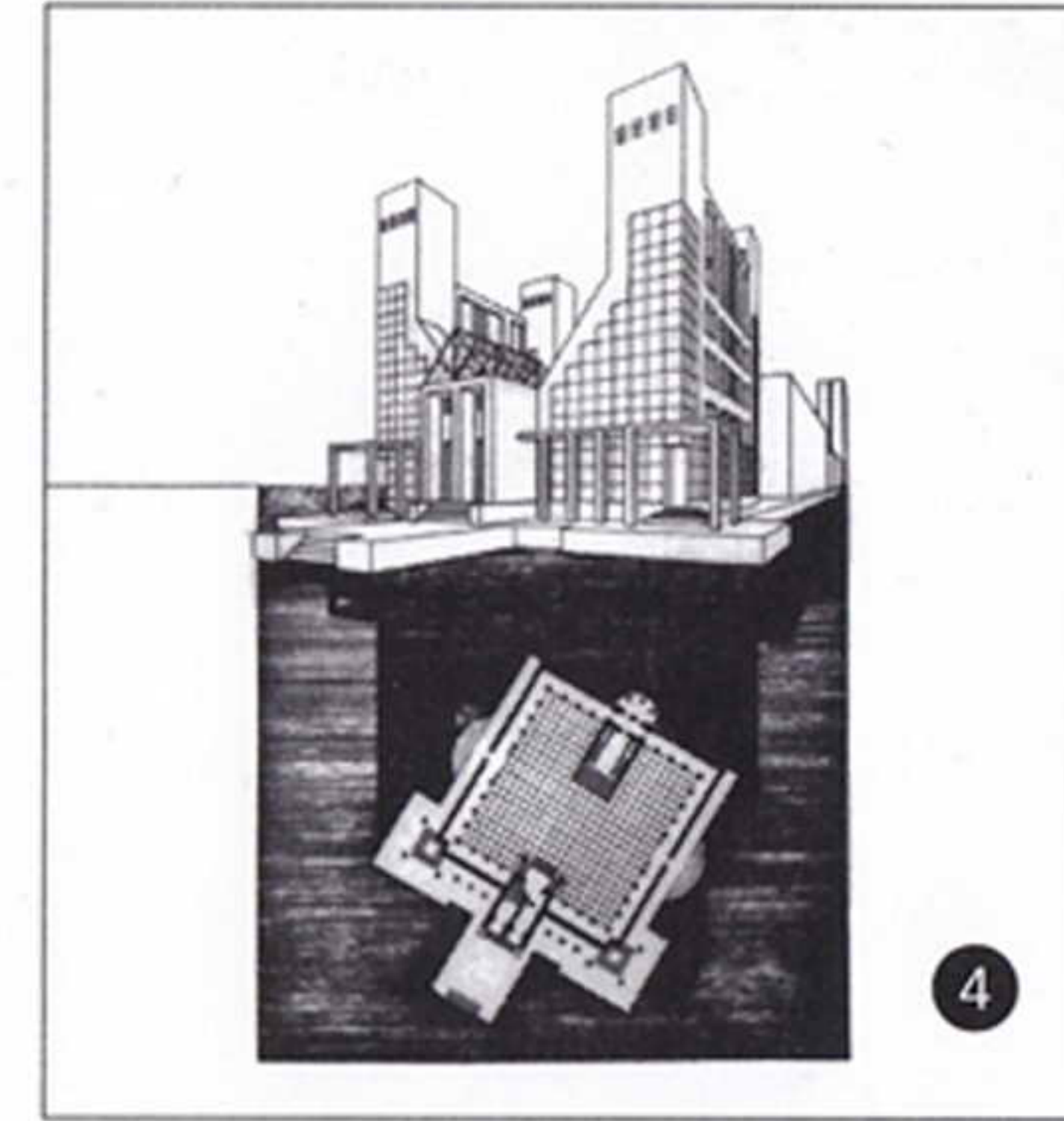

4

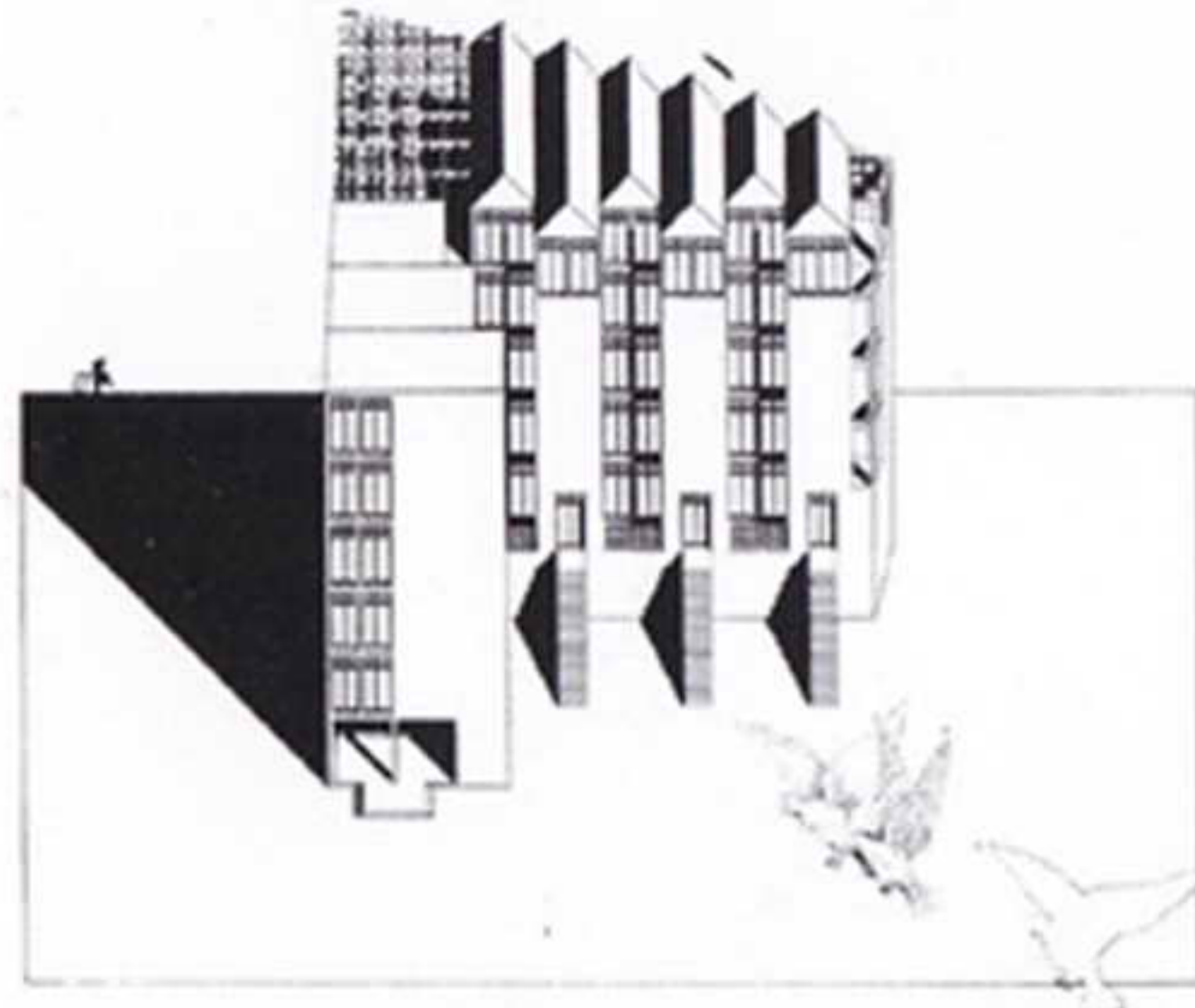

10



11

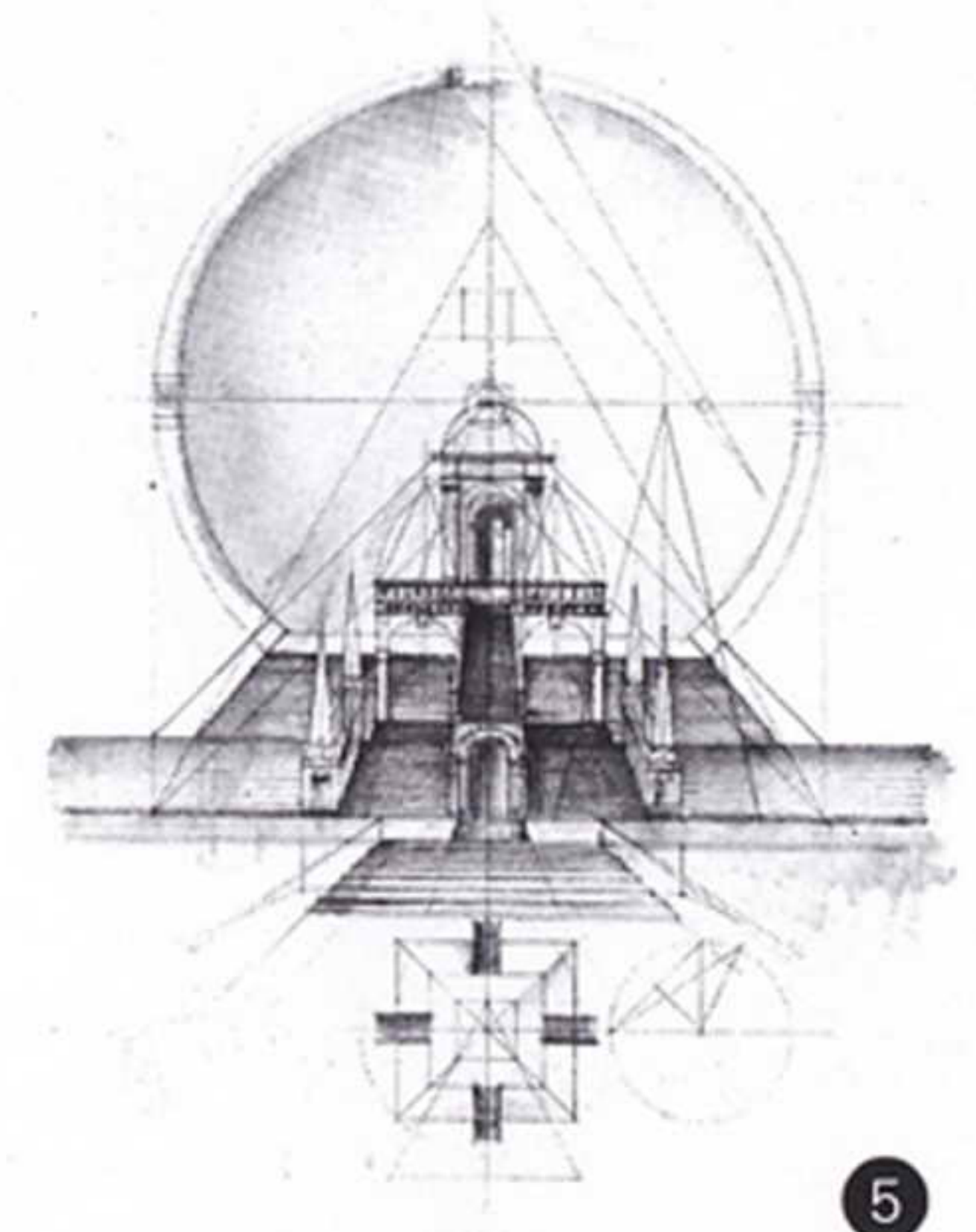

5

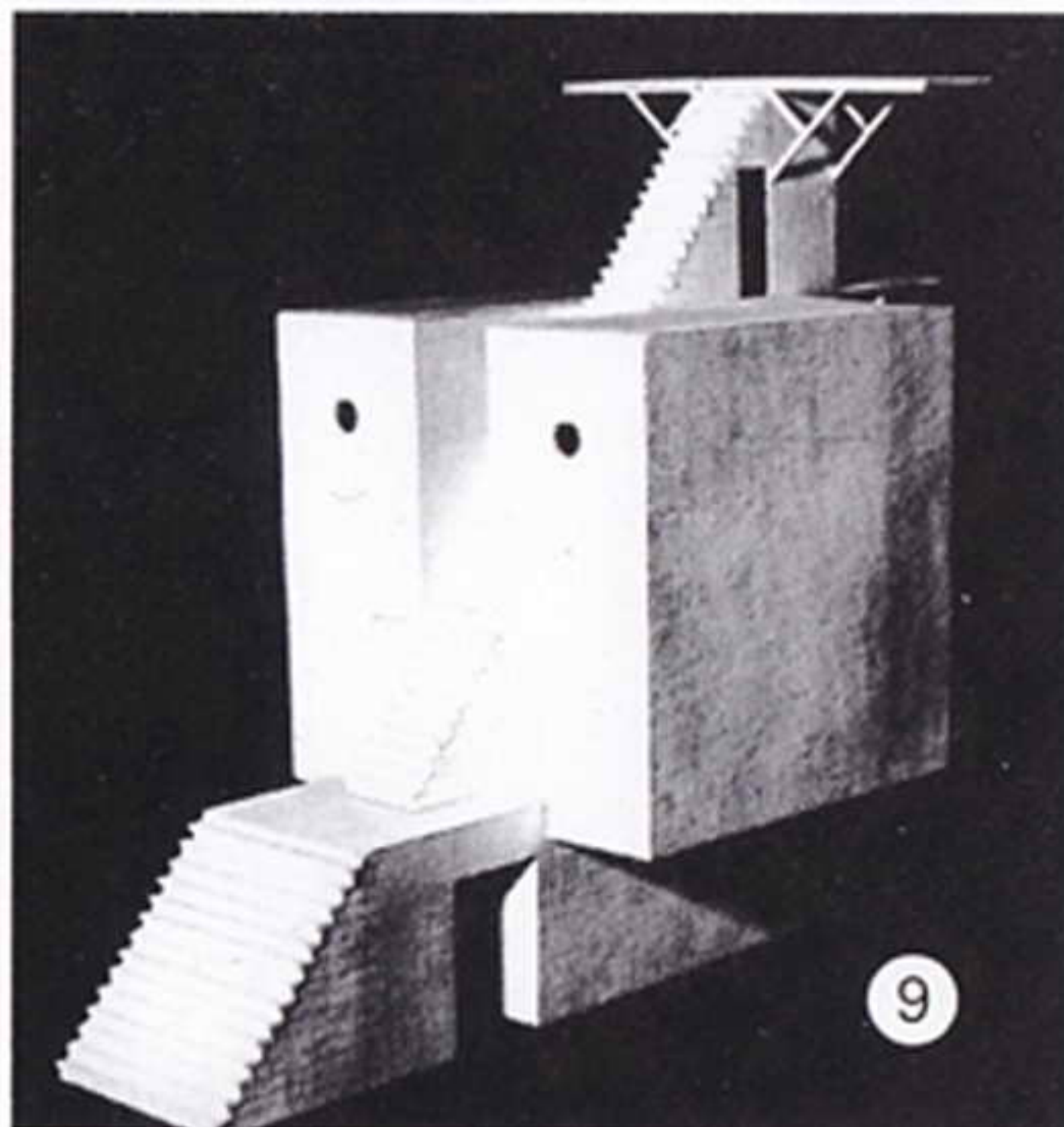

9

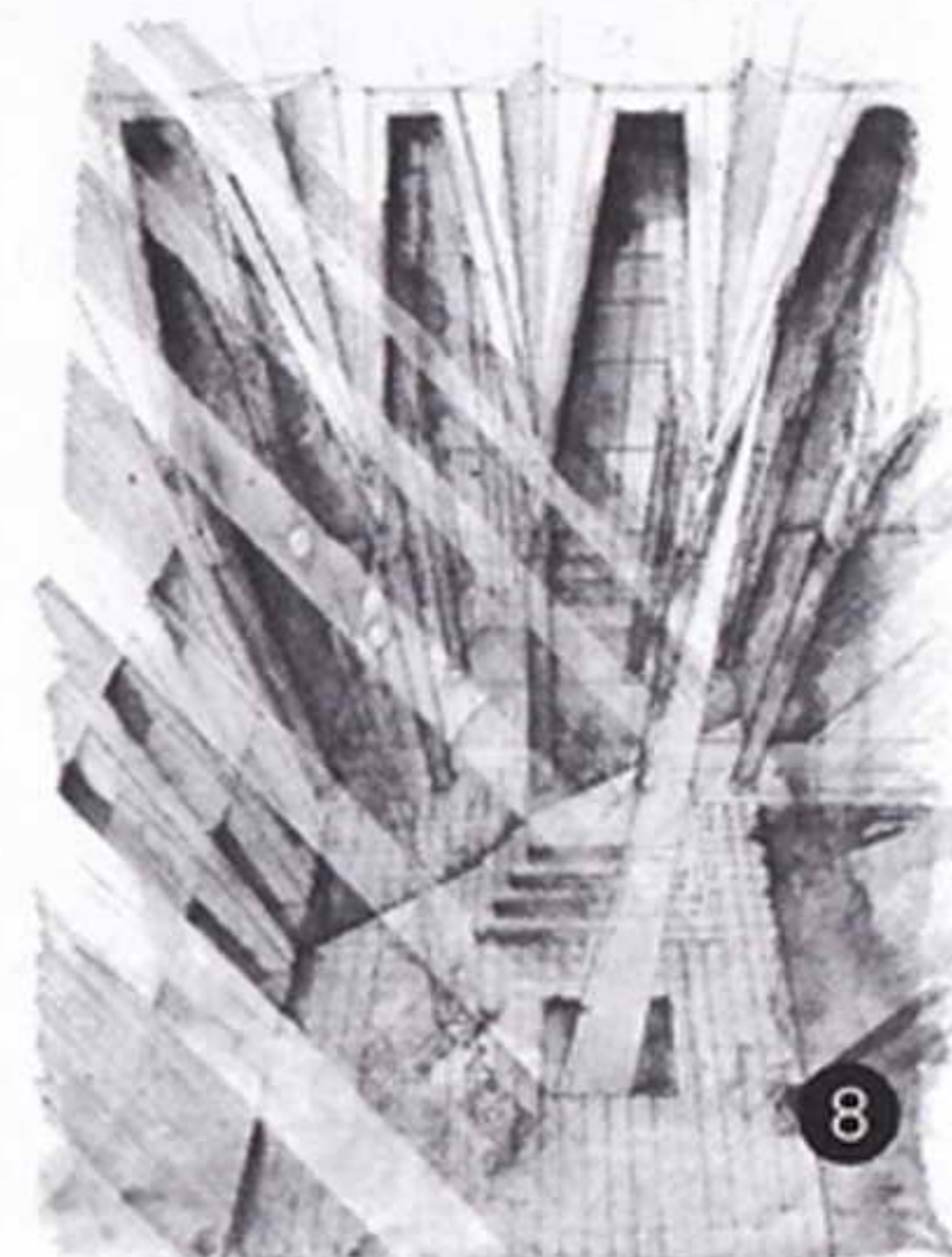

8

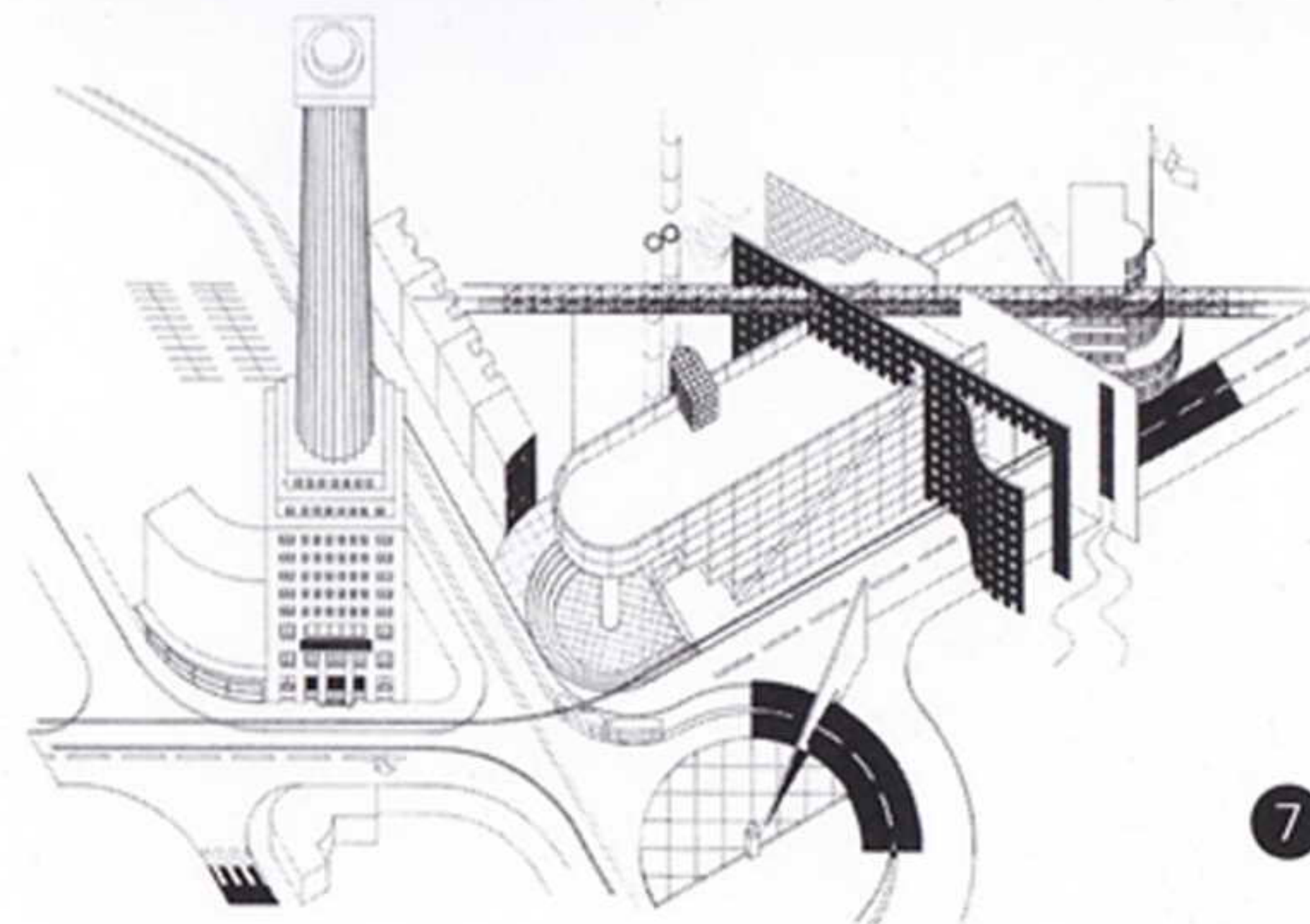

7

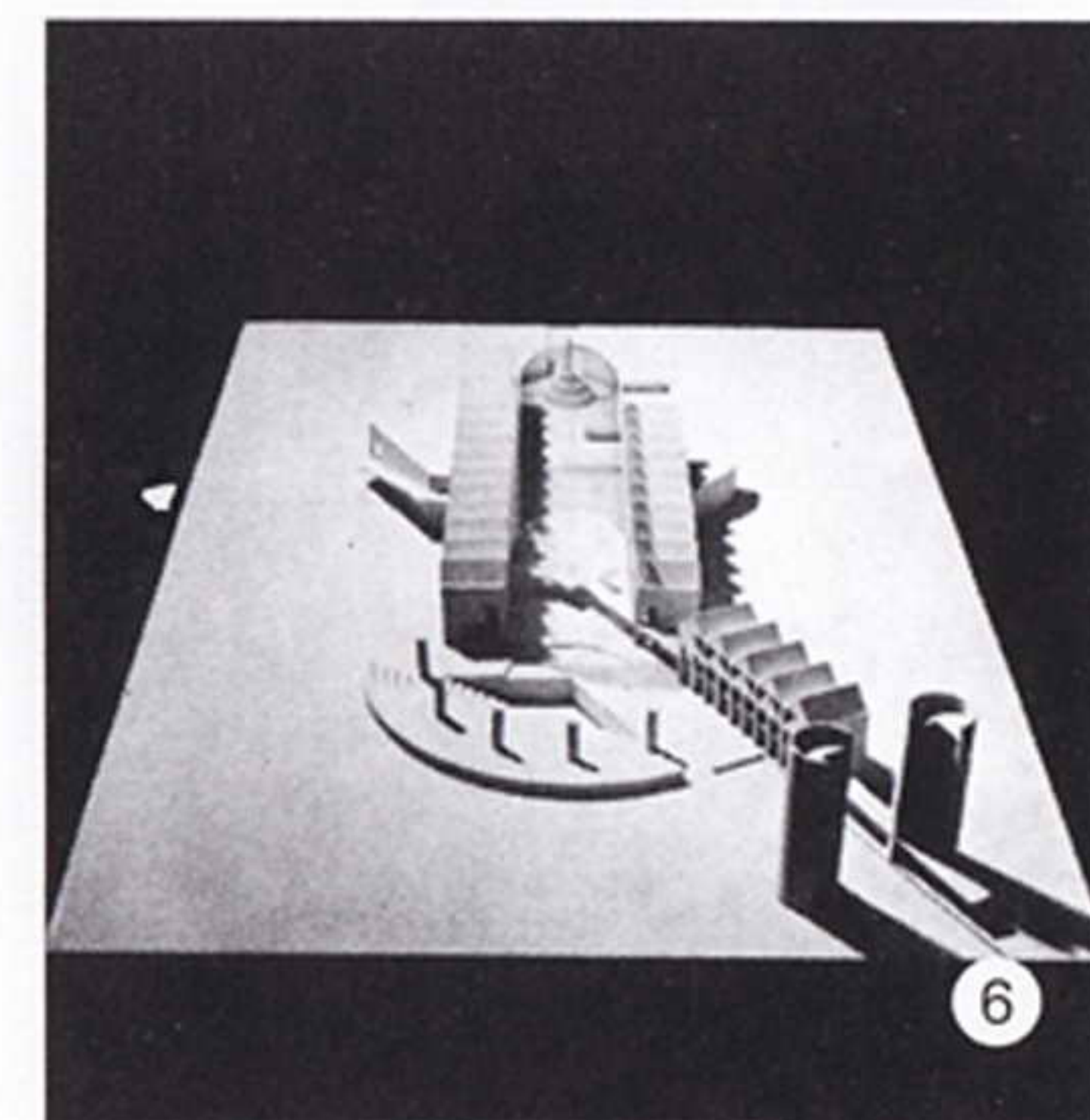

6

Tenis klub "Vračar", Beograd, Južni bulevar 69, studija (1994) /
Tennis Club "Vračar", Belgrade, Južni bulevar 69, study (1994)

Mustafa Musić

